



# CP3249-GABSYG / CP3249-GABSUD

Part no : 6159945110  
 Issue no : 01  
 Seris no : C  
 Date : 06/2012  
 Page : 1 / 6

	Governor spring / Ressort de régulateur Mueller de regulador / Feder des Reglers				
CP3249-GABSYG	6 000 rpm	Orange	Orange	Naranja	Orange
CP3249-GABSUD	4 500 rpm	Purple	Violet	Violeta	Veilichenblau

	CP324. (mm)	CP323. (mm)
H maxi	23	19.9
H mini	21	17.9

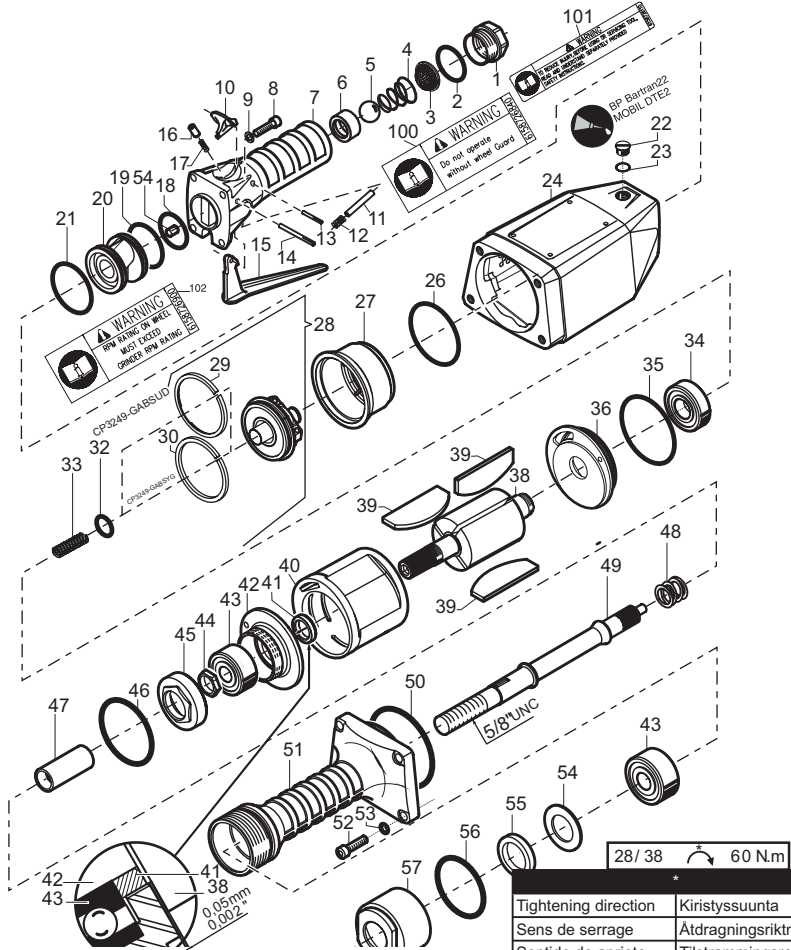

	CP3249-GABSYG	CP3249-GABSUD
rpm	6 000	4 500
W (hp)	3.62 (2 700)	3.22 (2 400)

Tightening direction	Kiristysuunta
Sens de serrage	Atdragningsriktning
Sentido de apriete	Tilstrammingsretning
Anziehrichtung	Tilspændingsretning
Senso di serraggio	Schroefrichting
Sentido de aperto	Φορά σύσφιξης

Part no : 6159945110  
 Issue no : 01  
 Seris no : C  
 Date : 06/2012  
 Page : 2 / 6

## CP3249-GABSYG / CP3249-GABSUD

Item Rep	New part no Réf. standard	Qty Qté	Specifics parts Pièces spécifiques	Description	Désignation
1	730.132	1		Adapter	Bague
2	6156581150	1		O ring	Joint torique
3	744.08	1		Strainer	Tamis
4	6156810200	1		Spring	Ressort
5	6157700190	1		Ball	Bille
6	6153210800	1		Seat	Siège de bille
7	315.30	4		Throttle handle	Corps de robinet
8	616.99	4		Screw	Vis
9	645.35	1		Washer	Rondelle
10	6153210820	1		Latch lever	Verrou
11	790.12	1		Pin	Aiguille
12	6156810190	1		Spring	Ressort
13	638.06	1		Roll pin	Goupille
14	6156380050	1		Roll pin	Goupille
15	6156380830	1		Safety lever	Levier
16	321.81	1		Cover	Coiffe
17	681.18	1		Spring	Ressort
18	658.107	1		O ring	Joint torique
19	658.112	1		O ring	Joint torique
20	321.72	1		Oil tank	Réservoir d'huile
21	658.130	1		O ring	Joint torique
22	614.02	1		Screw	Vis
23	650.16	1		Gasket	Joint
24	6153962780	1		Motor Housing	Carter Turbine
26	658.118	1		O ring	Joint torique
27	6153211830	1		Governor housing	Boîtier de régulation
28	6154570340	1	CP3249-GABSUD	Governor 4.5K (29)	Régulateur 4,5K (29)
28	6154570320	1	CP3249-GABSYG	Governor 6K (30)	Régulateur 6K (30)
29	6153201300	1	CP3249-GABSUD	Ring overspeed 4.5K	Anneau de survitesse
30	6153201280	1	CP3249-GABSYG	Ring overspeed 6K	Anneau de survitesse
32	658.120	1		O ring	Joint torique
33	6156811040	1	CP3249-GABSYG	Spring of governor 6K	Ressort de régulateur

**CP3249-GABSYG / CP3249-GABSUD**

Part no : 6159945110  
Issue no : 01  
Seris no : C  
Date : 06/2012  
Page : 3 / 6

Item Rep	New part no Réf. standard	Qty Qté	Specifics parts Pièces spécifiques	Description	Désignation
33	6156811030	1	CP3249-GABSUD	Spring of governor 4.5K	Ressort de régulateur
34	758.17	1		Ball bearing	Roulement
35	658.124	1		O ring	Joint torique
36	6154221490	1		Rear plate-end	Joue AR
38	426.68	1		Rotor	Rotor
39	434.48	3		Vane	Palette
40	400.120	1		Liner	Cylindre
41	661.75	1		Collar rotor	Bague de joue
42	420.119	1		Front end plate (41)	Joue AV (41)
43	754.17	2		Ball bearing	Roulement
44	607.49	1		Nut	Ecrou
45	673.68	1		Plug	Bouchon
46	657.32	1		O ring	Joint torique
47	575.84	1		Coupling sleeve	Manchon d'accouplement
48	680.99	1		Spring	Ressort
49	501.36	1		Shaft	Arbre porte-meule
50	658.116	1		O ring	Joint torique
51	552.19	1		Handle	Poignée AV
52	223133	4		Screw	Vis
53	640.06	4		Washer	Rondelle
54	643.54	1		Washer	Rondelle
55	654.05	1		Felt	Feutre
56	658.113	1		O ring	Joint torique
57	673.69	1	CP3249-GABSYG	Plug	Bouchon AV fileté
57	673.70	1	CP3249-GABSUD	Plug	Bouchon AV fileté
58	675.06	1		Oiler	Graisseur
100	6158726840	1		Warning guard label	Etiquette protecteur
101	6158726110	1		Warning instruction	Etiquette instructions
102	6158726900	1		Warning wheel speed label	Etiquette vitesse meuleuse

Part no : 6159945110  
 Issue no : 01  
 Seris no : C  
 Date : 06/2012  
 Page : 4 / 6

**CP3249-GABSYG / CP3249-GABSUD**

**Accessories included**  
**Mitgeliefertes Zubehör**  
**Varusteet**  
**Leveret tilbehør**

**Accessoires livrés**  
**Accessori forniti**  
**Levererade tillbehör**  
**Geleverde accessoires**

**Accesorios suministrados**  
**Accessórios fornecidos**  
**Tilbehør som følger med**  
**Παρεχόμενα εξαρτήματα**



Item Rep	New part no Réf. standard	Qty Qté	Description	Désignation
60	6157040140	1	1/2" air hose nipple for 5/8" ID hose	Busette 1/2" pour tuyau Ø int. 60 15 mm

Ø8" (Ø220mm) For straight grinding wheel / Pour meuleuse droite

**CP3249-GABSUD**

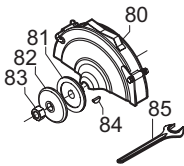

Item Rep	New part no Réf. standard	Qty Qté	Description	Désignation
80	6155040780	1	Wheel guard 8"	Protecteur
81	6155030040	1	Rear flange	Flasque AR
82	6155020070	1	Front flange	Flasque AV
83	6156080060	1	Nut	Ecrou
84	6156300190		Woodruff key	Clavette
85	6158010770		Flat wrench 1-1/16"	Clé plate de 27 mm

## CP3249-GABSYG / CP3249-GABSUD

Part no : 6159945110  
 Issue no : 01  
 Seris no : C  
 Date : 06/2012  
 Page : 5 / 6

**Accessories included**  
**Mitgeliefertes Zubehör**  
**Varusteet**  
**Leveret tilbehør**

**Accessoires livrés**  
**Accessori forniti**  
**Levererade tillbehör**  
**Geleverde accessoires**

**Accesorios suministrados**  
**Accessórios fornecidos**  
**Tilbehør som følger med**  
**Παρεχόμενα εξαρτήματα**

Ø6-5/8" (Ø165mm) Flap wheel assembly / *Montage roue à lamelles*

CP3249-GABSYG

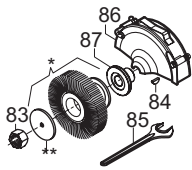

Item Rep	New part no Réf. standard	Qty Qté	Description	Désignation
86	6155040790	1	Wheel guard	Protecteur
87	6155030280	1	Rear flange	Flasque AR
83	6156080060	1	Nut	Ecrou
84	6156300190	1	Woodruff key	Clavette
85	6158010770	1	Flat wrench 1-1/16"	Clé plate de 27 mm
*			Accessory not supplied	Accessoire non fourni

Flange supplied with flap wheel. To be drilled to fit the diameter of the output shaft of the tool.  
*Flasque livré avec la roue à lamelles. À percer au diamètre de l'arbre de sortie de la machine.*

Ø6" (Ø150mm) For straight grinding wheel / *Pour meuleuse droite*

CP3249-GABSYG

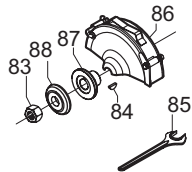

Item Rep	New part no Réf. standard	Qty Qté	Description	Désignation
86	6155040790	1	Wheel guard	Protecteur
87	6155030280	1	Rear flange	Flasque AR
88	6155020270	1	Front flange	Flasque AV
83	6156080060	1	Nut	Ecrou
84	6156300190	1	Woodruff key	Clavette
85	6158010770	1	Flat wrench 1-1/16"	Clé plate de 27 mm

Ø6" (Ø150mm) For straight grinding wheel / *Pour meuleuse droite*

CP3249-GABSYG

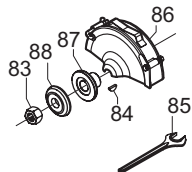

Item Rep	New part no Réf. standard	Qty Qté	Description	Désignation
86	6155040790	1	Wheel guard	Protecteur
87	6155030280	1	Rear flange	Flasque AR
88	6155020270	1	Front flange	Flasque AV
83	6156080060	1	Nut	Ecrou
84	6156300190	1	Woodruff key	Clavette
85	6158010770	1	Flat wrench 1-1/16"	Clé plate de 27 mm

Part no : 6159945110  
 Issue no : 01  
 Seris no : C  
 Date : 06/2012  
 Page : 6 / 6

**CP3249-GABSYG / CP3249-GABSUD**

**Accessories included**  
**Mitgeliefertes Zubehör**  
**Varusteet**  
**Leveret tilbehør**

**Accessoires livrés**  
**Accessori forniti**  
**Levererade tillbehör**  
**Geleverde accessoires**

**Accesorios suministrados**  
**Accessórios fornecidos**  
**Tilbehør som følger med**  
**Παρεχόμενα εξαρτήματα**

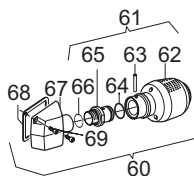

Item Rep	New part no Réf. standard	Qty Qté	Description	Désignation
60	6153994600	1	Complete silencer kit	Kit silencieux complet
61	399.463	1	Complete silencer	Silencieux complet
62	399.736	1	Silencer	Silencieux
63	637.50	1	Roll pin	Goupille
64	658.164	1	O ring	Joint torique
65	730.172	1	Adapter	Bague de raccordement
66	658.246	1	O ring	Joint torique
67	570.338	1	Collector	Collecteur
68	656.57	1	Gasket	Joint papier
69	616.66	2	Screw	Vis

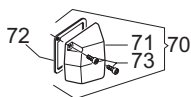

Item Rep	New part no Réf. standard	Qty Qté	Description	Désignation
70	615 399227 0	1	Complete silencer kit	Kit silencieux complet
71	570.159	1	Silencer	Silencieux
72	656.57	1	Gasket	Joint papier
73	616.66	2	Screw	Vis