

# PRODUCT INFORMATION

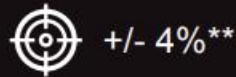

+/- 4%\*\*



Connected\*



Data collection\*



Sequence programming\*



Tool lock. Error proof\*



Application library\*

\* C or CQ version only

\*\* Based on hard joint 15° at nominal torque

## CP86 Series

### CHICAGO PNEUMATIC BATTERY TORQUE WRENCH



CP8613 : Up to 1300 Nm / 960 ft.lbs



CP8626 : Up to 2600 Nm / 1900 ft.lbs



CP8641 : Up to 4100 Nm / 3100 ft.lbs



CP8681 : Up to 8100 Nm / 5975 ft.lbs

## Product description

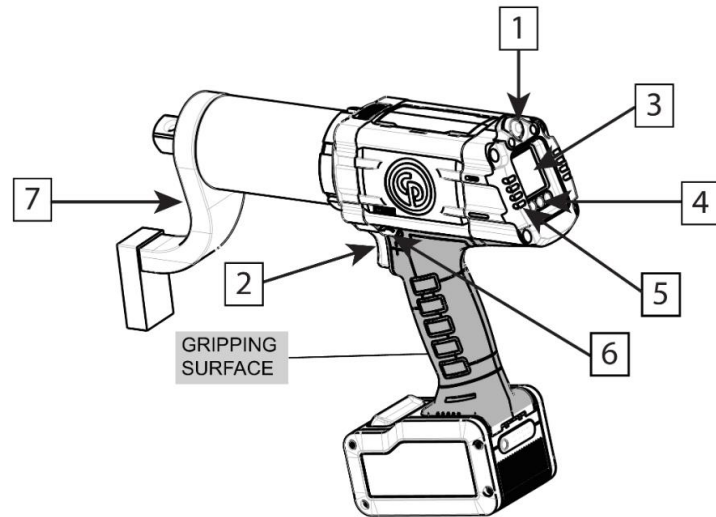

- 
- 1 Second trigger
  - 2 Principle trigger
  - 3 Display screen
  - 4 Settings buttons
  - 5 Reporting LEDs
  - 6 Reverse button
  - 7 Reaction bar s-type (delivered with the tool)
- 

## Connected version

To unblock functionalities of CP86 connected versions C and CQ, download CPLinQ to your device and connect your tool to CPLinQ app.

# CPLinQ



## Installation & Operating Instructions

- Battery CP36XP25 (8940176068)

Battery wake up : Remove white protective sticker and plug the battery to CP charger CP18-36CH (8940176069).

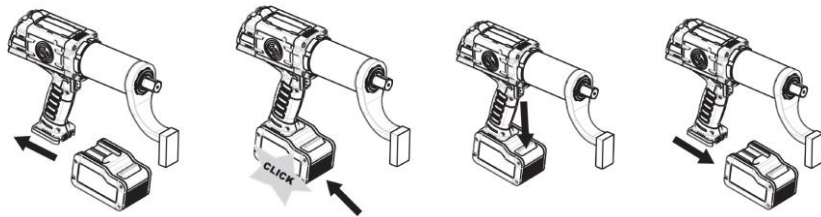

- Reaction bar & Socket

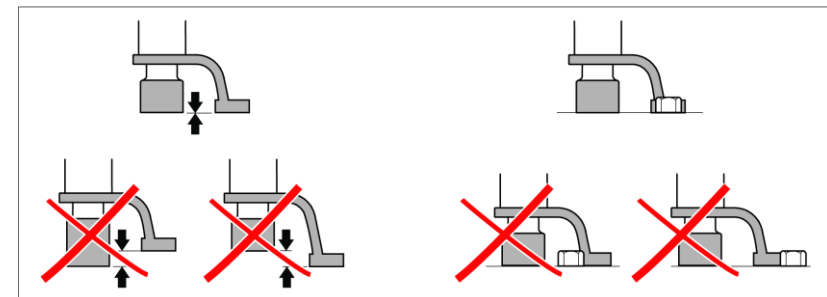
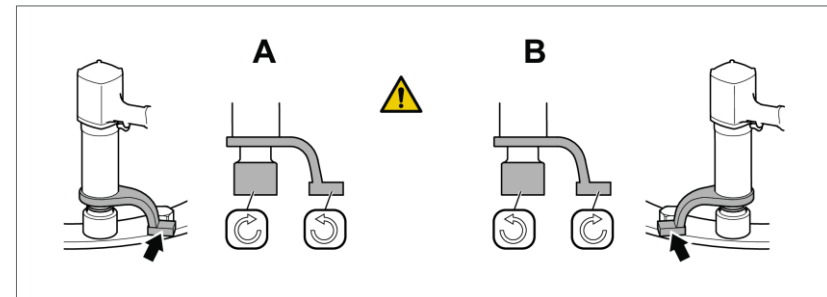
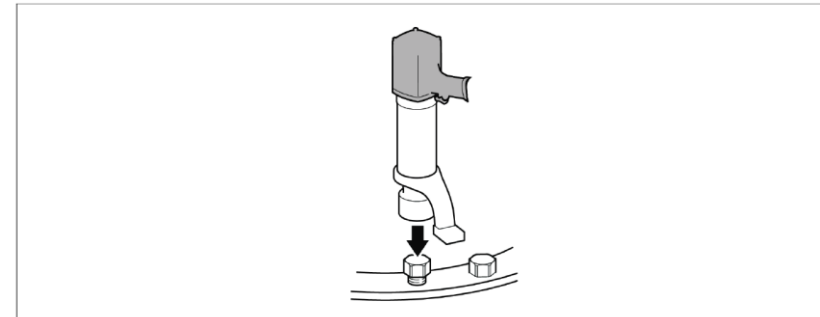
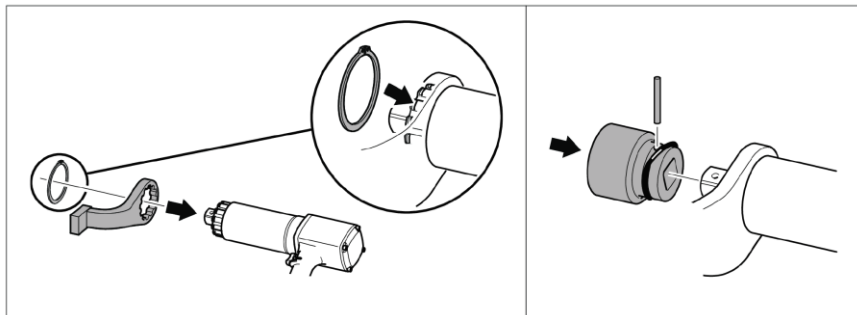

## Starting the tool

Fit the tool with a suitable socket.

Set the appropriate program on the tool.

Hold the tool by means of the handle, place the reaction bar on a suitable reaction point and apply to the fastener to be tightened.

 **WARNING Risk of Injury**

As the reaction force increases in proportion to the tightening torque, there is a risk of severe bodily injury of the operator as a result of unexpected behavior of the tool.

► Make sure that the tool is in perfect working order.

 **WARNING Risk of Burns**



The motor may heat up during heavy duty cycles.

► Wear gloves.

 **WARNING Crushing Hazard**



Do a check of the rotational direction of the tool before start! A start in an unexpected rotational direction can cause bodily injury or property damage

► Make sure that the rotational direction of the tool is correct before starting the tool.

► Keep your hands away from the reaction bar while the tool is used.

► Press triggers to start the tool

## Operating the tool



## Torque set up



Stand alone tools menu

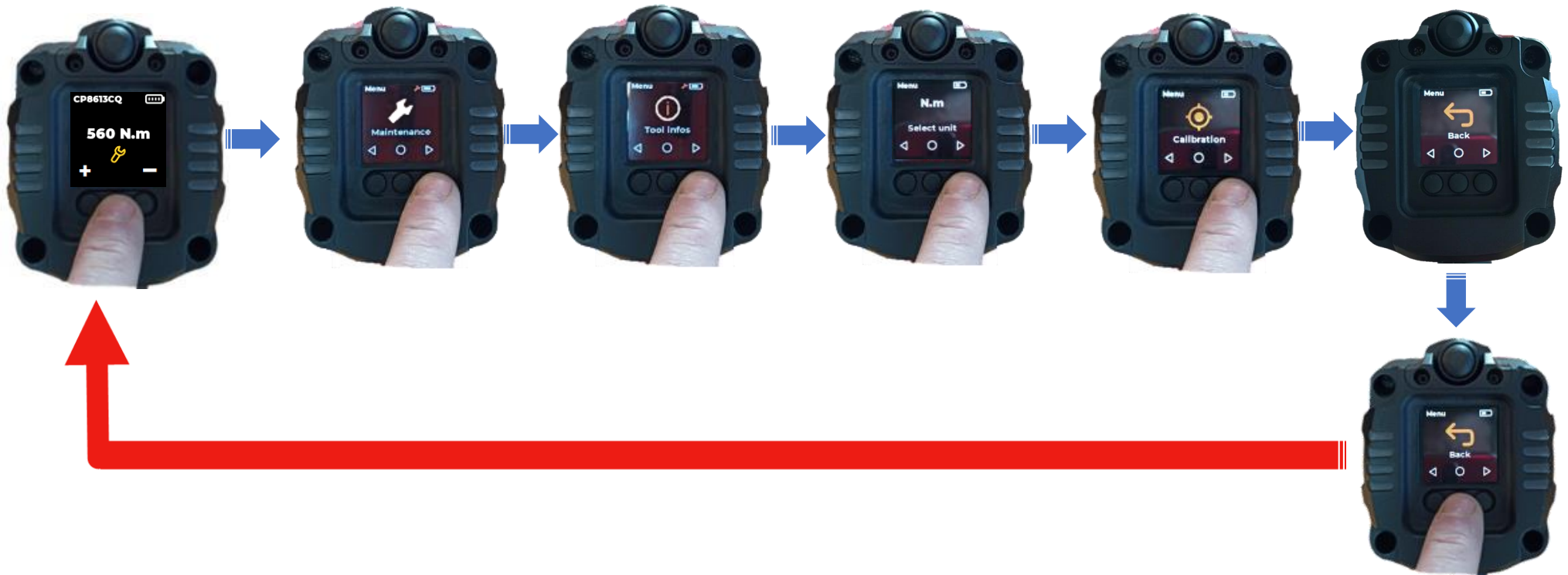

# Maintenance menu



Tools information menu













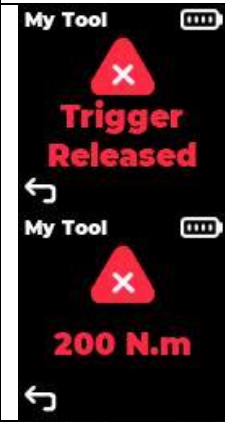
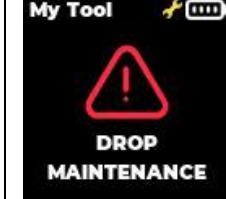



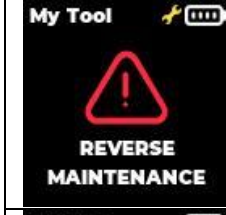

# Units selection menu

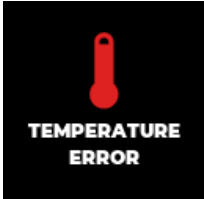

## Troubleshooting

	<p>Triggers have been used in bad order</p>	<p>Press the second trigger first (1) and maintain, then press main trigger (2) and maintain both until end of tightening (refer to product description)</p>		<p>The nutrunner needs a maintenance due to time of operation</p>	<p>Contact service center</p>
	<p>One of the triggers has been released during tightening. Torque or angle achieved is shown</p>	<p>Maintain both triggers until end of tightening</p>		<p>The nutrunner needs a maintenance due to too many drops</p>	
	<p>Torque higher than maximum authorized OR angle not achievable because of tool capacity exceeded</p>			<p>The nutrunner needs a maintenance due to number of tightening</p>	
	<p>The tool has detected a rehit. You are probably trying to tighten an already tightened bolt</p>			<p>The nutrunner needs a maintenance due to number of untightening</p>	
				<p>Level of battery is under 25%</p>	<p>Replace battery by fully loaded battery as soon as possible (refer to battery wake up procedure if needed)</p>

 <b>EMPTY BATTERY</b>	<p>Level of battery is under 5%</p>	<p>Replace battery by fully loaded battery, tool will turn off (refer to battery wake up procedure if needed)</p>	 <b>BATTERY ERROR</b>	<p>The tool is unable to communicate with the battery.</p>	<ol style="list-style-type: none"> <li>1. Check if you are using the right Battery (8940176068)</li> <li>2. If the problem occurs again, contact your CP representative for support.</li> </ol>						
 <b>FLASH ERROR</b>	<p>Tool system issue</p>	<p>Contact service center</p>	 <b>TEMPERATURE ERROR</b>	<p>The tool is out functional temperature range.</p>	<ol style="list-style-type: none"> <li>1. Wait the tool cool down</li> <li>2. Reduce duty cycle</li> <li>3. If the problem occurs again, contact your CP representative for support.</li> </ol>						
 <b>FAN ISSUE</b>			<p>Tool system issue</p>	<p>Contact service center</p>	<p>Tool doesn't start</p>		<ol style="list-style-type: none"> <li>1. Check that your Battery is awake</li> <li>2. Check Battery charge level</li> <li>3. If the problem occurs again, contact your CP representative for support.</li> </ol>				
 <b>MEMORY ERROR</b>					<p>Tool system issue</p>	<p>Contact service center</p>	<p>Your tool cannot connect to CPLINQ</p>		<ol style="list-style-type: none"> <li>1. Check that your Bluetooth is active on your terminal</li> <li>2. If the problem occurs again, contact your CP representative for support.</li> </ol>		
 <b>DRIVE ERROR</b>							<p>Tool system issue</p>	<p>Contact service center</p>			

## Service & maintenance

Overhaul and preventive maintenance are recommended at regular intervals.

Maintenance should be performed by qualified personnel only.

Website Information concerning our Products, Accessories, Spare Parts, exploded views and Published Matters can be found on the CP website. Please visit: [www.cp.com](http://www.cp.com).

The use of spare parts other than those originally supplied by the manufacturer may result in a drop in performance or in increased maintenance and level of vibration and in the full cancellation of the manufacturer's liability.

For tool calibration or all other servicing operation, refer to your local service center.