

Foot
 Ordering No. 205 053 6513

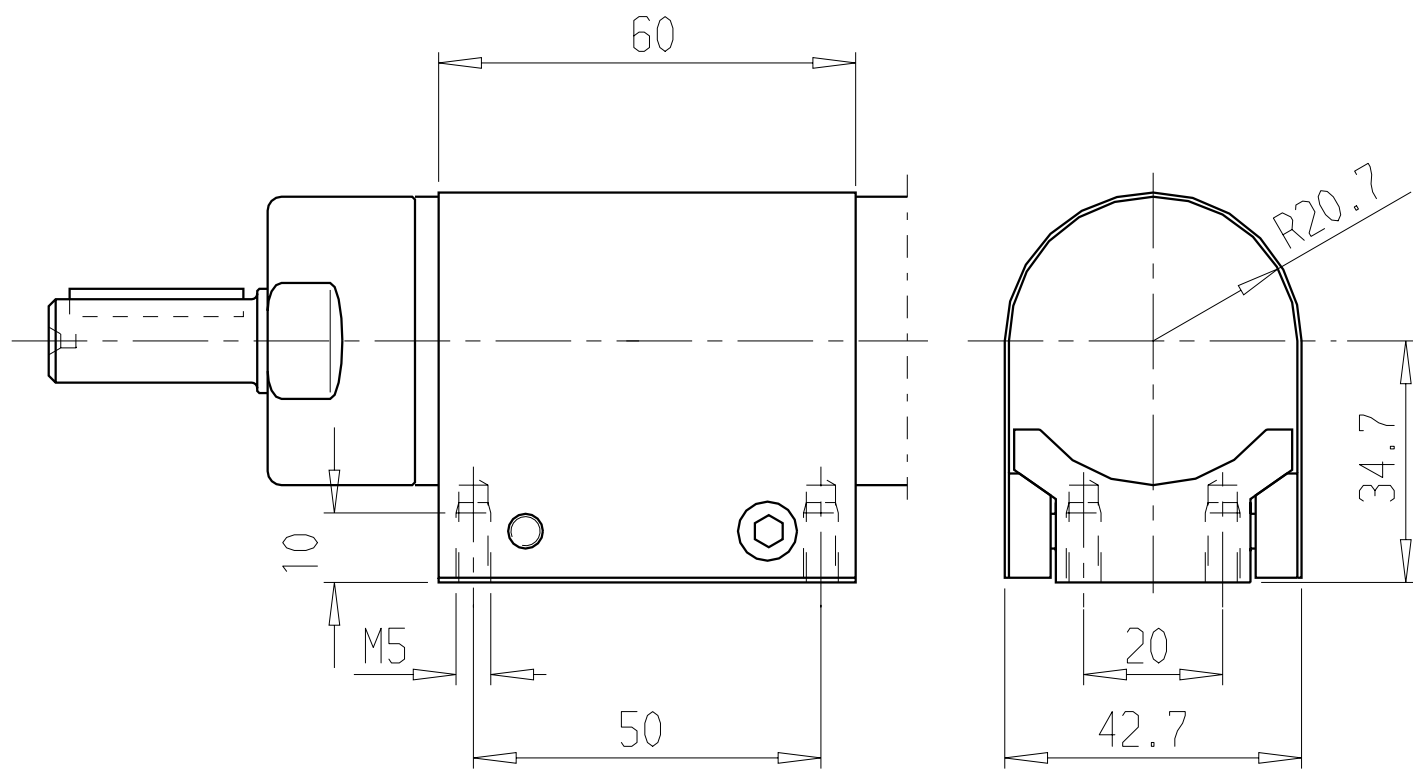

Flange
 Ordering No. 205 053 6433

